

## VETROCEMENTO

### SIMBOLI NEL CATALOGO / SYMBOLS IN THE CATALOG

  
Codice prodotto

  
Modello

  
Colore

  
Pezzi in confezione

  
Pezzi sul bancale

  
Dimensione bancale

  
Peso

## ■ VETROCEMENTO NUVOLA 19X19 CM

Importato da GRUPPO SIBAR, questo articolo è in grado di soddisfare qualsiasi esigenza architettonica e strutturale, inoltre ha un'eccellente resistenza agli sbalzi di temperatura, agli urti e alla compressione. Disponibile in diverse colorazioni. **Materiale:** Vetro.

### COLORI



**VE19I-11**  
Nuvola trasparente  
19x19cm



**VE19I-12**  
Nuvola verde  
19x19cm



**VE19I-13**  
Nuvola celeste  
19x19cm



**VE19I-14**  
Nuvola rosa  
19x19cm



### SCHEDA ORDINE PRODOTTO

COD.	MOD.*						€/pz
VE19I-11	19x19	○	6	360	110x110x120	2,240 kg/pz	6,10
VE19I-12	19x19	●	6	360	110x110x120	2,240 kg/pz	11,65
VE19I-13	19x19	●	6	360	110x110x120	2,240 kg/pz	11,65
VE19I-14	19x19	●	6	360	110x110x120	2,240 kg/pz	11,65

\*MISURE IN CENTIMETRI

### SCHEDA TECNICA PRODOTTO

MOD.*	L*	P*
19x19	19	8

\*MISURE IN CENTIMETRI

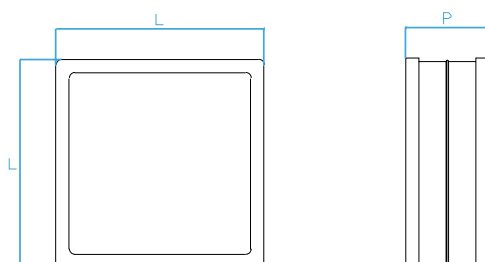

# ■ VETROCEMENTO NUVOLA SATINATO 19x19 cm

Importato da GRUPPO SIBAR, questo articolo è in grado di soddisfare qualsiasi esigenza architettonica e strutturale, inoltre ha un'eccellente resistenza agli sbalzi di temperatura, agli urti e alla compressione. Disponibile in diverse colorazioni. Materiale: Vetro.

## COLORI



**VE19S-01**  
Nuvola bianco  
satinato  
19x19cm



**VE19S-03**  
Nuvola verde  
satinato  
19x19cm



**VE19S-06**  
Nuvola celeste  
satinato  
19x19cm



**VE19S-02**  
Nuvola rosa  
satinato  
19x19cm



SCHEDA ORDINE PRODOTTO							
€/pz	COD.	MOD.*					
14,10	VE19S-01	19x19		6	360	110x110x120	2,240 kg/pz
15,16	VE19S-03	19x19		6	360	110x110x120	2,240 kg/pz
15,16	VE19S-06	19x19		6	360	110x110x120	2,240 kg/pz
15,16	VE19S-02	19x19		6	360	110x110x120	2,240 kg/pz

\*MISURE IN CENTIMETRI

SCHEDA TECNICA PRODOTTO		
MOD.*	L*	P*
19x19	19	8

\*MISURE IN CENTIMETRI

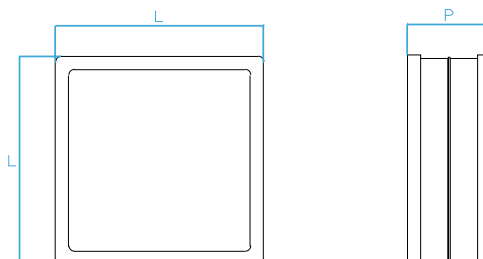

VETROCEMENTO

N.B. I PESI INDICATI POSSONO ESSERE SOGGETTI A VARIAZIONE DEL +/- 10%

## ■ VETROCEMENTO NUVOLA TRASPARENTE 24X24CM - 19X9CM - PIASTRA VETRO

Importato da GRUPPO SIBAR, la piastra vetro è ideale per strutture orizzontali sia interne che esterne per la realizzazione di lucernari per pavimento. E' molto resistente agli sbalzi di temperatura, agli urti e alla compressione. **Materiale:** Vetro.

**VE24I-01**  
Nuvola trasparente  
24X24cm



**VE9I-01**  
Nuvola trasparente  
19x9cm



**PVETRO**  
Piastra vetro  
20x20cm



### COLORI



**Dettaglio laterale**  
Vetrocimento 19x9cm



**Dettaglio laterale**  
Vetrocimento 24x24cm

### SCHEDA ORDINE PRODOTTO

COD.	MOD.*						€/pz
VE24I-01	24x24	○	5	200	120x90x120	4,000 kg/pz	19,44
VE9I-01	19x9	○	10	720	120x90x120	1,400 kg/pz	7,35
PVETRO	Piastra Vetro	○	10	540	110x110x75	1,960 kg/pz	15,37

\*MISURE IN CENTIMETRI

### SCHEDA TECNICA PRODOTTO

MOD.*	L*	B*	C*	P*
24x24	24	--	--	8
19x9	9	19	--	8
Piastra Vetro	20	19,5	16,5	2,7

\*MISURE IN CENTIMETRI

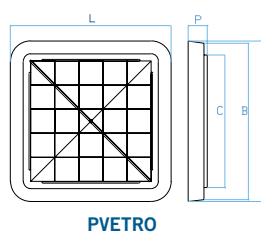
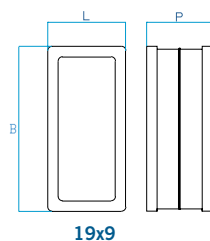
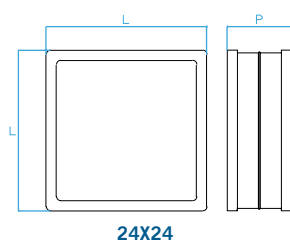

## FORMELLE E DISTANZIATORI PER VETROCEMENTO

Le formelle sono prodotte da GRUPPO SIBAR sono adatte per il montaggio orizzontale della piastra in vetro e del vetrocemento, rendendo più semplice e veloce la posa in opera. Il distanziatore per vetrocemento permette di evitare gli sprechi di colla e consente il perfetto allineamento dei mattoni.

**Materiale:** - Formelle Polipropilene Copolimero, Distanziatore per vetrocamera polistirolo.

### COLORI

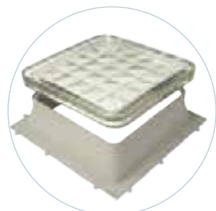

Esempio di montaggio della formella per piastra vetro

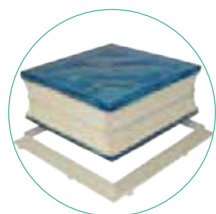

Esempio di montaggio della formella per vetrocemento

**FORMPIASTRA-01**  
Formella piastra



Esempio di installazione dei distanziatori

**FORMELLA**  
Formella vetro



**DV00-02**  
**DV00-03**  
Distanziatore



SCHEDA ORDINE PRODOTTO							
€/pz	COD.	MOD.*					
0,28	DV00-03	Distanziatore	●	100	12800	100x120x220	0,014 kg/pz
0,27	DV00-02	Distanziatore	●	250	13500	100x120x220	0,014 kg/pz
2,94	FORMELLA	Formella Vetro	●	32	1536	110x110x120	0,058 kg/pz
3,40	FORMPIASTRA-01	Formella Piastra	●	35	1400	110x110x120	0,103 kg/pz

\*MISURE IN CENTIMETRI

SCHEDA TECNICA PRODOTTO							
MOD.	A*	B*	C*	D*	E*	H*	
Distanziatore	6,5	8,2	6,6	7	3	2,7	
Formella Vetro	19	18,2	--	--	--	1	
Formella Piastra	23	16,2	--	--	--	5,2	

\*MISURE IN CENTIMETRI

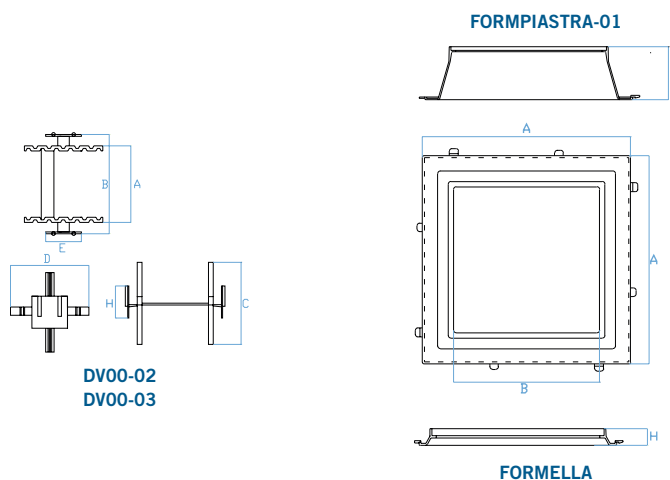

N.B. I PESI INDICATI POSSONO ESSERE SOGGETTI A VARIAZIONE DEL +/- 10%

# TELAIO PORTA VETRO

Il telaio porta vetro importato da GRUPPO SIBAR, consente la creazione di aperture per la ventilazione senza rovinare l'estetica della struttura e dando continuità alla stessa. **Materiale:** Metallo smaltato bianco.

## COLORI



**TEVE04-01**  
Telaio per 4 posti



**TEVE02-01**  
Telaio per 2 posti



**TEVE01-01**  
Telaio per 1 posto

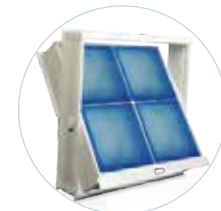

Esempio montaggio telaio porta vetro 4 posti

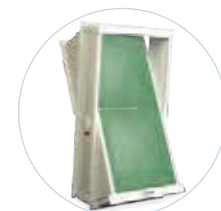

Esempio montaggio telaio porta vetro 2 posti

### SCHEDA ORDINE PRODOTTO

COD.	MOD.*						€/pz
TEVE01-01	19x19 - 1 posto	<input type="radio"/>	1	--	--	1,636 kg/pz	91,00
TEVE02-01	19x39 - 2 posti	<input type="radio"/>	1	--	--	2,430 kg/pz	102,40
TEVE04-01	39x39 - 4 posti	<input type="radio"/>	1	--	--	3,380 kg/pz	153,60

\*MISURE IN CENTIMETRI

### SCHEDA TECNICA PRODOTTO

Mod.*	P*	L*	H*
19x19 - 1 posto	8,5	--	21,5
19x39 - 2 posti	8,5	21,5	41
39x39 - 4 posti	8,5	--	41

\*MISURE IN CENTIMETRI



Esempio montaggio telaio porta vetro 1 posto

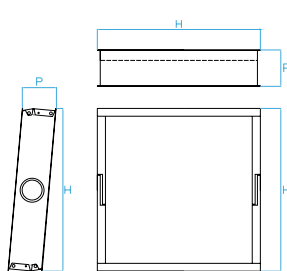

**TEVE01-01**  
**TEVE04-01**

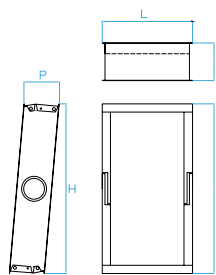

**TEVE02-01**